

Soportes

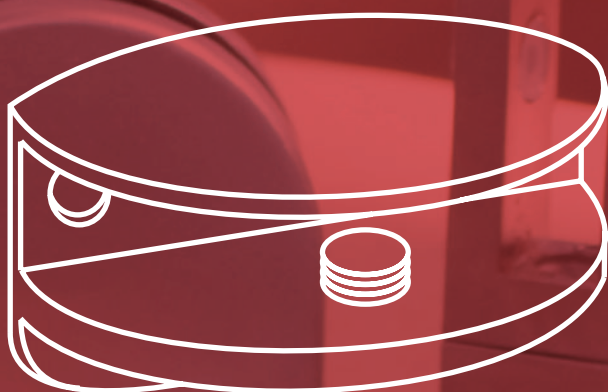
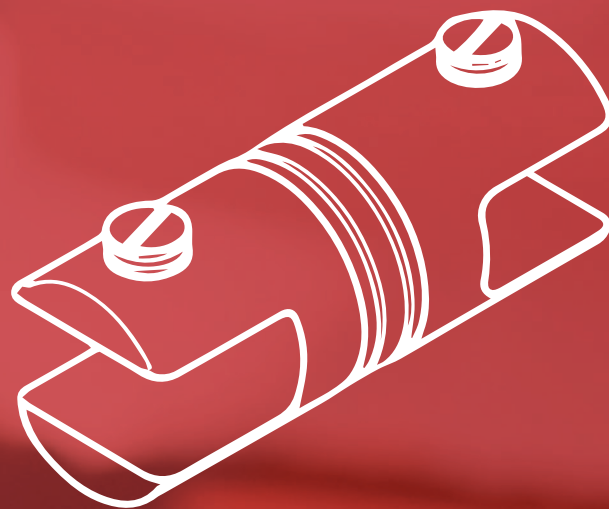

12.1 - ESTANTERÍAS.....	556-563
12.2 - MAMPARAS PROTECTORAS.....	564-568
12.3 - RÓTULOS.....	569

12.1 - ESTANTERÍAS
SOPORTE SENCILLO MURAL

3276.0

Ø 20 mm
 Vidrio 6/8 mm
 Fijación con 1 tornillo
 Apriete del vidrio con tornillo

Acabados:

Plata brillo	1600.1 PB
Plata mate	1600.1 PM

*Pedido mínimo: 4 unidades.

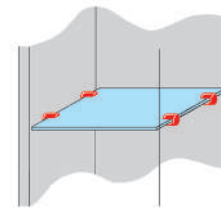
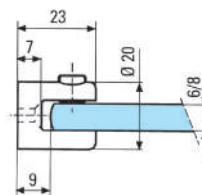
SOPORTE SENCILLO DE VITRINA

3277.0

Ø 20 mm
 Vidrio 6/8 mm
 Montaje con taladro Ø 8 mm
 Apriete del vidrio con tornillo con tope de corcho
 Se suministra con 2 juntas PVC
 traslúcidas de 1 mm de espesor

Acabados:

Plata brillo	1600 PB
Plata mate	1600 PM

*Pedido mínimo: 4 unidades.

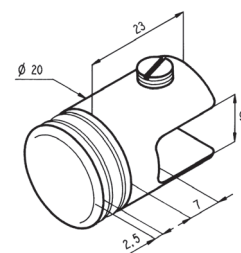
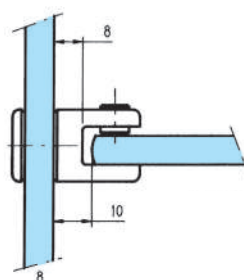
SOPORTE DOBLE DE VITRINA

3278.0

Ø 20 mm
 Vidrio 6/8 mm
 Montaje con taladro Ø 8 mm
 Apriete del vidrio con tornillo con tope de corcho
 Se suministra con 2 juntas PVC
 traslúcidas de 1 mm de espesor

Acabados:

Plata brillo	1605 PB
Plata mate	1605 PM

*Pedido mínimo: 2 unidades.

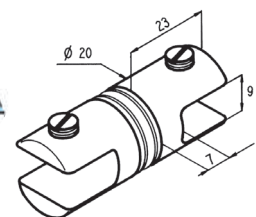
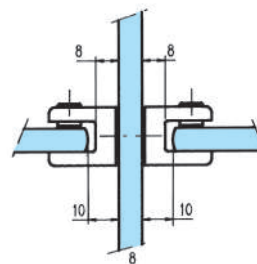
SOPORTE DE ESTANTE PARA ATORNILLAR
14 X 12 MM

5660.0

Tornillo Ø 4 mm y 12 mm de longitud
 Material: latón

Acabados:

Plata brillo	1640 PB
--------------	----------------

*Pedido mínimo: 10 unidades.

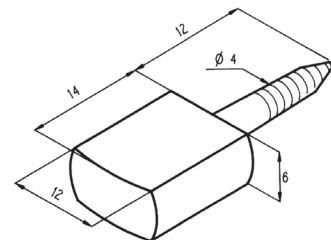
SOPORTE DE ESTANTE PARA ATORNILLAR
25 X 15 MM

5660.5

Tornillo Ø 4 mm y 20 mm de longitud
 Material: latón

Acabados:

Plata brillo	1641 PB
--------------	----------------

*Pedido mínimo: 10 unidades.

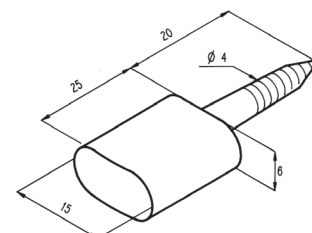

SOPORTA ESTANTE CON CASQUILLO

14 X 12 MM

Casquillo de latón Ø 8,5 mm

Material: latón

Acabados:

Plata brillo	1642 PB
--------------	----------------

*Pedido mínimo: 10 unidades.

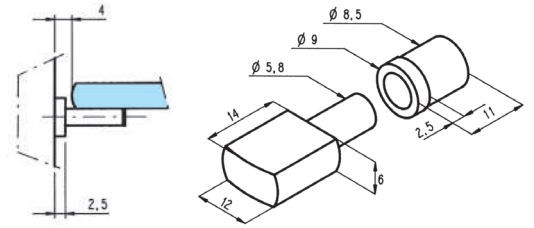

5660.6

SOPORTA ESTANTE

15 x 15 mm

Vidrio 4/6 mm

Material: latón

Acabados:

Plata brillo	1730 PB
Plata mate	1730 PM

*Pedido mínimo: 10 unidades.

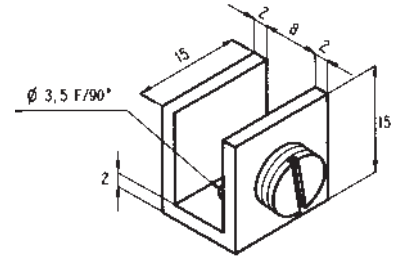

5630.2

SOPORTA ESTANTE

15 X 15 MM

Vidrio 4/8 mm

Material: latón

Acabados:

Plata brillo	1731 PB
Plata mate	1731 PM

*Pedido mínimo: 10 unidades.

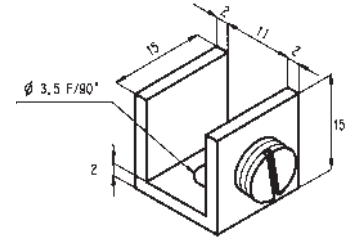

5630.3

SOPORTA ESTANTE

27 X 16 MM

Vidrio 6/8 mm

Material: latón

Acabados:

Plata brillo	1732 PB
Plata mate	1732 PM

*Pedido mínimo: 10 unidades.

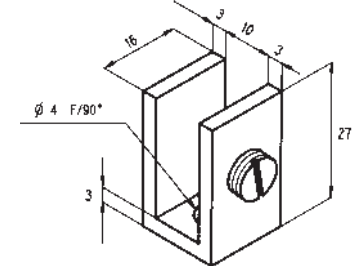

5630.4

SOPORTA ESTANTE

27 X 25 MM

Vidrio 6/8 mm

Material: latón

Acabados:

Plata brillo	1733 PB
Plata mate	1733 PM

*Pedido mínimo: 4 unidades.

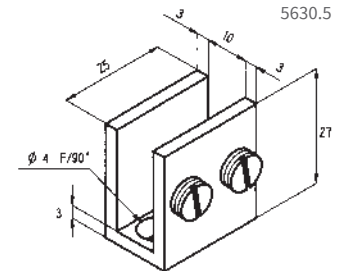

5630.5

SOPORTA ESTANTE

27 X 50 MM

Vidrio 6/8 mm

Material: latón

Acabados:

Plata brillo	1734 PB
Plata mate	1734 PM

*Pedido mínimo: 4 unidades.

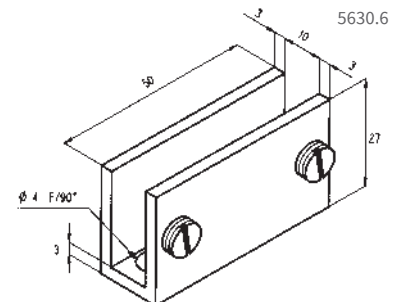

5630.6

SOPORTA ESTANTE METÁLICO VIDRIO 6/40 MM

Peso máximo con 2 soportes: 12 kg
Salida máxima de vidrio: 160 mm
Material: metal fundido - estampado

Acabados:

Plata brillo	786 PB
Plata mate	786 PM

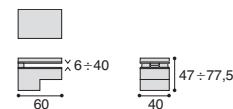

SOPORTA ESTANTE METÁLICO VIDRIO 6/40 MM

Peso máximo con 2 soportes: 18 kg
Salida máxima de vidrio: 210 mm
Material: metal fundido - estampado

Acabados:

Plata brillo	787 PB
Plata mate	787 PM

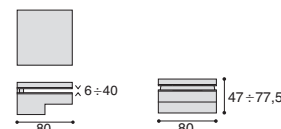

SOPORTA ESTANTE METÁLICO VIDRIO 4/35 MM

Peso máximo con 2 soportes: 12 kg
Salida máxima de vidrio: 160 mm
Material: metal fundido - estampado

Acabados:

Plata brillo	789 PB
Plata mate	789 PM

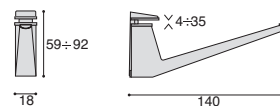
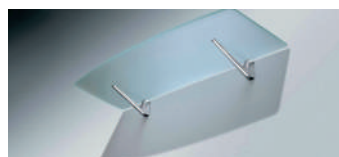

SOPORTA ESTANTE METÁLICO VIDRIO 4/45 MM

Peso máximo con 2 soportes: 17 kg
Salida máxima de vidrio: 210 mm
Material: metal fundido - estampado

Acabados:

Plata brillo	790 PB
Plata mate	790 PM

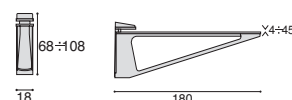
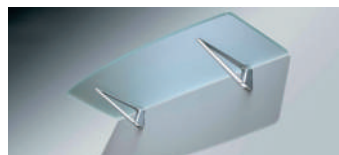

SOPORTA ESTANTE METÁLICO VIDRIO 6/10 MM

Peso máximo con 2 soportes: 10 kg
Salida máxima de vidrio: 100 mm
Material: metal fundido - estampado

Acabados:

Plata brillo	791 PB
Plata mate	791 PM

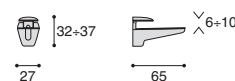

SOPORTA ESTANTE METÁLICO VIDRIO 6/20 MM

Peso máximo con 2 soportes: 10 kg
Salida máxima de vidrio: 160 mm
Material: metal fundido - estampado

Acabados:

Plata brillo	792 PB
Plata mate	792 PM

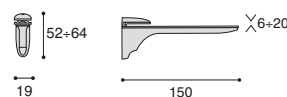

SOPORTA ESTANTE METÁLICO VIDRIO 6/20 MM

Peso máximo con 2 soportes: 30 kg
Salida máxima de vidrio: 200 mm
Material: metal fundido - estampado

Acabados:

Plata brillo	793 PB
Plata mate	793 PM

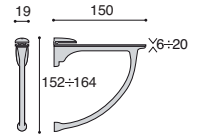

SOPORTE PLÁSTICO

Acabados:

Ø 14 mm

Marrón	811 MA
Blanco	811 BL

Ø 20 mm

Marrón	811.1 MA
Blanco	811.1 BL

*Bolsa de 50 unidades

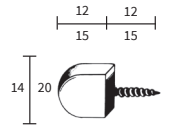

SOPORTE METAL Ø 18 mm

Acabados:

Plata	812 PL
Oro	812 OR
Plata brillo	812 PB
Oro brillo	812 OB

*Bolsa de 50 unidades

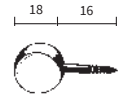

SOPORTE METAL - GOMA Ø 14 mm

Con ventosa transparente
Ref. 608 incluida

Acabados:

Plata	815 PL
Oro	815 OR

*Bolsa de 50 unidades

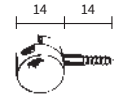

SOPORTE METAL - GOMA ESCUADRA

Vidrio 5/10 mm

Acabados:

Plata	816 PL
Oro	816 OR

*Bolsa de 50 unidades

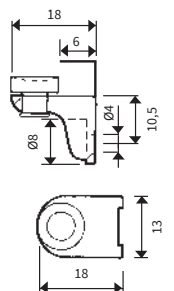

SOPORTA ESTANTE METÁLICO REDONDO ZAMAK A PARED

Con taladro avellanado

Acabados:

Vidrio: 5/6 mm

Plata brillo	806.1 PB
Oro brillo	806.1 OB
Blanco	806.1 BL

Vidrio: 8/10 mm

Plata brillo	807.1 PB
Oro brillo	807.1 OB
Blanco	807.1 BL

*Bolsa de 10 unidades

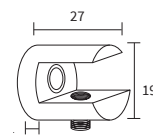
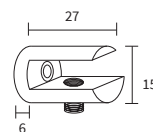
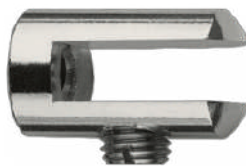

SOPORTA ESTANTE METÁLICO REDONDO LATÓN

Con tornillo trasero cónico.

Taladro vidrio Ø 8 mm

Acabados:

Vidrio: 5/6 mm

Plata brillo	806 PB
Plata mate	806 PM
Oro brillo	806 OB
Blanco	806 BL

Vidrio: 8/10 mm

Plata brillo	807 PB
Plata mate	807 PM
Oro brillo	807 OB
Blanco	807 BL

*Bolsa de 10 unidades

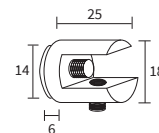
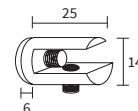

SOPORTA ESTANTE METÁLICO RECTANGULAR

Vidrio 5/6 mm

Acabados:

Plata brillo	801.1 PB
Oro brillo	801.1 OB
Blanco	801.1 BL
Negro	801.1 NE

*Pedido mínimo 2 unidades

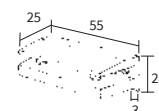

SOPORTA ESTANTE METÁLICO RECTANGULAR

Vidrio 8/10 mm

Acabados:

Plata brillo	803 PB
Blanco	803 BL

*Pedido mínimo 2 unidades

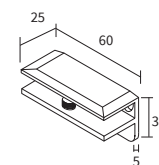

SOPORTA ESTANTE METÁLICO

Acabados:

Vidrio 5/6 mm

Plata brillo	802 PB
Plata mate	802 PM
Oro brillo	802 OB
Oro mate	802 OM
Blanco	802 BL
Negro	802 NE

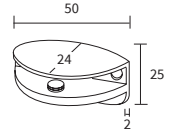

Vidrio: 8/10 mm

Plata brillo	804 PB
Plata mate	804 PM
Oro brillo	804 OB
Oro mate	804 OM
Blanco	804 BL
Negro	804 NE

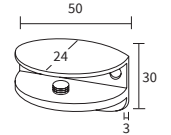

*Pedido mínimo 2 unidades

SOPORTA ESTANTE METÁLICO ECO

Acabados:

Vidrio 5/6 mm

Plata brillo	802.1 PB
Oro brillo	802.1 OB
Blanco	802.1 BL
Negro	802.1 NE

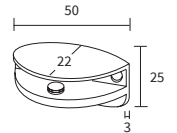

Vidrio: 8/10 mm

Plata brillo	804.1 PB
Oro brillo	804.1 OB
Blanco	804.1 BL
Negro	804.1 NE

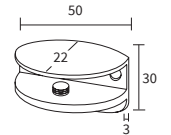

*Pedido mínimo 2 unidades

SOPORTA ESTANTE METÁLICO ECO

Vidrio 7/10 mm

Material: zamak inyectado a presión

Peso máximo con 2 soportes: 6 kg

Salida máxima de vidrio: 100 mm

Acabados:

Plata brillo	797 PB
Plata mate	797 PM

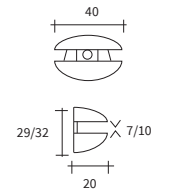

*Pedido mínimo 2 unidades

Vidrio 5/16 mm

Material: zamak inyectado a presión

Peso máximo con 2 soportes: 12 kg

Salida máxima de vidrio: 110 mm

Acabados:

Plata brillo	798 PB
Plata mate	798 PM

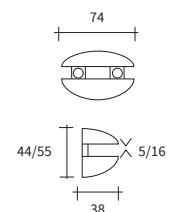

*Pedido mínimo 2 unidades

SOPORTA ESTANTE CLIP

Vidrio 4/19 mm

Acabados:

Plata brillo	810 PB
Plata mate	810 PM
Oro brillo	810 OB
Oro mate	810 OM
Blanco	810 BL

*Pedido mínimo 2 unidades

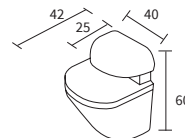

SOPORTA ESTANTE CLIP MINI

Vidrio 4/19 mm

Acabados:

Plata brillo	810.1 PB
Plata mate	810.1 PM
Oro brillo	810.1 OB
Oro mate	810.1 OM
Blanco	810.1 BL

*Pedido mínimo 2 unidades

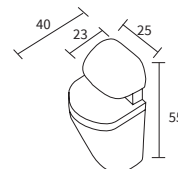

SOPORTA ESTANTE PINZA BLOC

Vidrio 6/25 mm

Resistencia: Máximo 40 kg uniformemente repartidos entre 2 soportes, con distancia entre soportes de máximo 60 cm

Profundidad máxima de estante: 35 cm

Soporte graduable y nivelable

Juntas protectoras de plástico semi-rígido para estantes de vidrio

Tornillo para regulación de nivel horizontal Sujeción total del estante

Materiales: Nylon y fibra de vidrio inyectados

Fijación a pared: 2 tornillos de 50 x 2,7 mm

Acabados:

Blanco	808 BL
Negro	808 NE
Gris	808 GR
Rojo	808 RO
Azul	808 AZ
Plata	808 PL

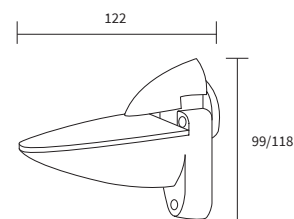

SOPORTA ESTANTE PINZA ALUMINIO

Vidrio 6/25 mm

Resistencia: Máximo 50 kg uniformemente repartidos entre 2 soportes, con distancia entre soportes de máximo 60 cm

Profundidad máxima de estante: 38 cm

Soporte graduable y nivelable

Juntas protectoras de plástico semi-rígido para estantes de vidrio

Tornillo para regulación de nivel horizontal

Sujeción total del estante

Material: Aluminio inyectado

Fijación a pared: 2 tornillos de 40 x 2,5 mm con tacos tipo Fischer

Tornillos y tacos especiales para paredes difíciles.

Margen de corrección para paredes desniveladas

Acabados:

Blanco	809 BL
Plata	809 PL

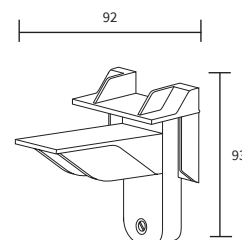
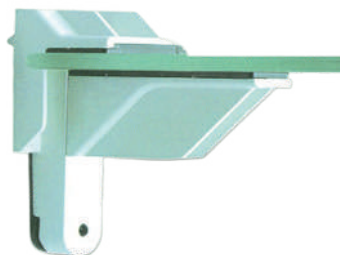

SOPORTA ESTANTE

BARRA ALUMINIO

Vidrio 10 mm directamente sin juntas

Vidrio 8 mm 1 junta de goma

Vidrio 6 mm 2 juntas de goma

Juntas de goma incluidas

Longitud: 3000 mm

Acabados:

Plata brillo	770 PB
Blanco	770 BL
Negro	770 NE

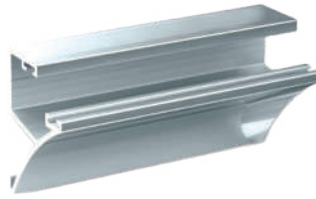

TAPAS (derecha e izquierda)

Acabados:

Plata brillo	770.T PB
Blanco	770.T BL
Negro	770.T NE

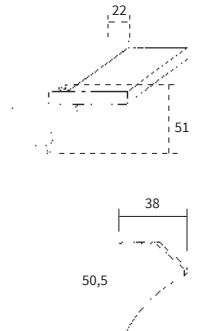

SOPORTA ESTANTE REDONDO

Acabados:

Vidrio 5/6 mm

Simple	Plata	820 PL
	Oro	820 OR
Doble	Plata	821 PL
	Oro	821 OR

Vidrio 8 mm

Simple	Plata	822 PL
	Oro	822 OR
Doble	Plata	823 PL
	Oro	823 OR

Vidrio 10 mm

Simple	Plata	824 PL
	Oro	824 OR
Doble	Plata	825 PL
	Oro	825 OR

*Bolsa de 10 unidades



820

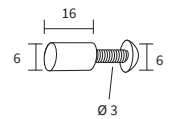

821



822

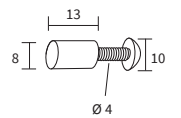

823

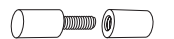

824

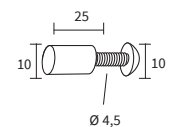

825



12.2 - MAMPARAS PROTECTORAS

SOPORTE PARA MAMPARA PROTECCIÓN

Para vidrio laminado de 6 a 10 mm de espesor

Antideslizantes

Acabados:

Para vidrio laminado de 1000 mm altura

Inox brillo	C19L180 IB
Inox mate	C19L180 IM
Negro	C19L180 NE

Para vidrio laminado de 800 mm altura

Inox brillo	C19L140 IB
Inox mate	C19L140 IM
Negro	C19L140 NE

Para vidrio laminado de 600 mm altura

Inox brillo	C19L90 IB
Inox mate	C19L90 IM
Negro	C19L90 NE



COV.1

C19L180
(altura mampara 1000)

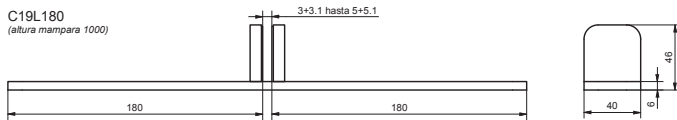

C19L140
(altura mampara 800)

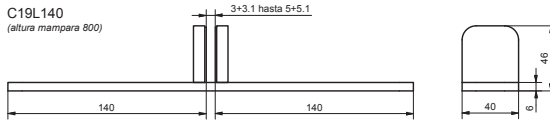

C19L90
(altura mampara 600)

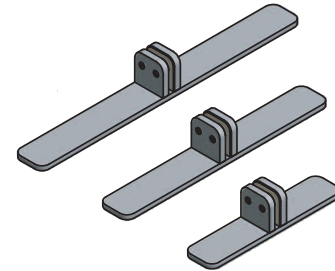
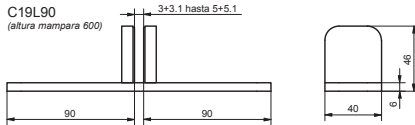

SOPORTE PARA MAMPARA PROTECCIÓN

Para vidrio templado de 6 a 10 mm de espesor

Antideslizantes

Para vidrio templado de 1000 mm altura

Acabados:

Inox brillo	C19T180 IB
Inox mate	C19T180 IM
Negro	C19T180 NE

Para vidrio templado de 800 mm altura

Inox brillo	C19T140 IB
Inox mate	C19T140 IM
Negro	C19T140 NE

Para vidrio templado de 600 mm altura

Inox brillo	C19T90 IB
Inox mate	C19T90 IM
Negro	C19T90 NE



COV.2

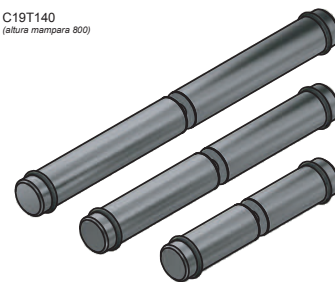
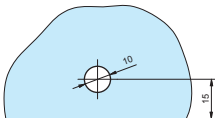
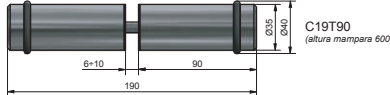
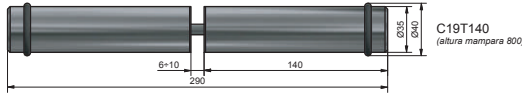
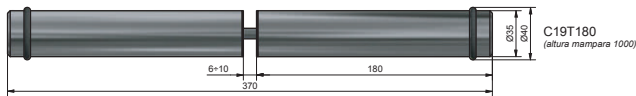

MAMPARA MÓVIL PROTECCIÓN

Para vidrio templado o laminado templado
Ruedas antivuelco y con bloqueo
Altura máxima: 1800 mm

Acabados:

Vidrio templado de 6 a 10 mm

Plata mate	C19LTMA PM
Lacado blanco	C19LTMA BL
Lacado negro	C19LTMA NE

Vidrio templado de 8 a 10 mm

Plata mate	C19LMA PM
Lacado blanco	C19LMA BL
Lacado negro	C19LMA NE

*Opción para vidrio laminado consultar

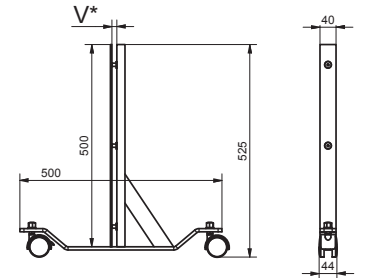
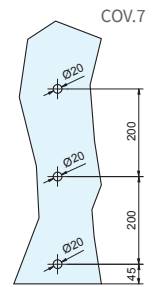

PINZAS DE FIJACIÓN

SOPORTE PINZA MESA + SOPORTE PINZA SUELO

Permite colocar mamparas integrales que cubran la altura de la persona de pie o sentada hasta los pies en el mostrador o mesa de trabajo.

Ideal para mostradores y oficinas de atención al público, como centros educativos, colegios, hospitales, centros médicos, oficinas o recepciones de hoteles.

SopORTE exclusivo en pinza que permite colocar diferentes mamparas y grosores en vidrio, metacrilato, policarbonato...

Características generales:

- Para vidrio laminado o templado y otros materiales
- Ajustable a diferentes grosores y formatos de mesa
- Espesor de vidrio: máximo 10 mm
- Espesor de mesa: máximo 40 mm, mínimo 20 mm
- Máxima estabilidad y seguridad
- Acabado: Inox mate



SOPORTE PINZA MESA

Espesor de vidrio: máximo 10 mm
Espesor de mesa: máximo 40 mm, mínimo 20 mm

Acabados:

Inox mate	C19SP IM
-----------	-----------------

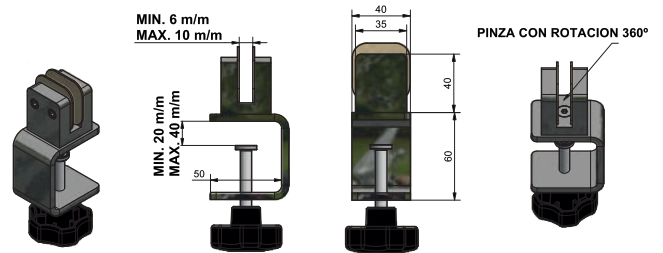

SOPORTE PINZA SUELO

Espesor de vidrio: máximo 10 mm

Acabados:

Inox mate	C19PSP IM
-----------	------------------

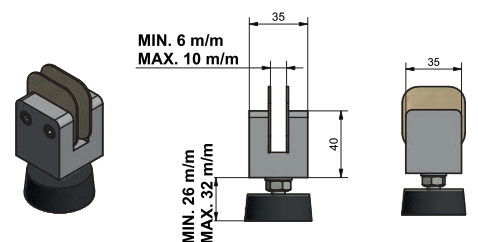

SOPORTE DE SOBREMESA PARA MAMPARAS DE PROTECCIÓN INOX

Para vidrio laminado de 3+3 y 4+4 mm

Las bases quedan fuertemente pegadas a la superficie mediante dos adhesivos (3M Command) creando una estructura rígida y resistente que impide que el vidrio pueda caer o moverse

Acabados:

Inox mate	V. 3+3 mm	30.45.18-080 IM
	V. 4+4 mm	30.45.18-081 IM

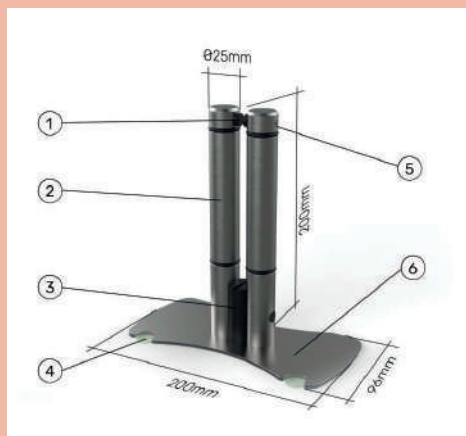

- 1 - Tacos plásticos para apoyo del vidrio
- 2 - Soportes verticales en acero inoxidable
- 3 - Taco de apoyo inferior
- 4 - Adhesivo 3M alta calidad para fijación a superficie con pestaña para retirar sin dejar residuos
- 5 - Perno de apriete para fijación del vidrio
- 6 - Base del conjunto en acero inoxidable



El adhesivo permite ser retirado sin dejar residuo



SISTEMA FIJACIÓN PARA MAMPARA DE PROTECCIÓN

Para vidrios/metacrilatos de 5 a 10 mm (sin agujerear) de hasta 700 mm de altura
 AISI 304

Fijación a madera hasta 45 mm de grosor (sin agujerear)

Pinza giratoria para instalación en paralelo o en perpendicular

Acabados:

Inox brillo	SEP01 IB
Inox mate	SEP01 IM

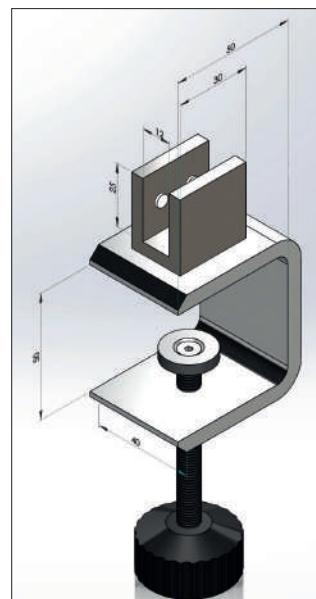
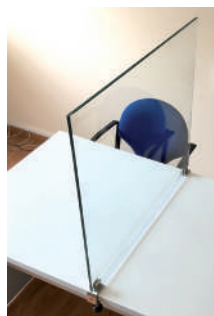
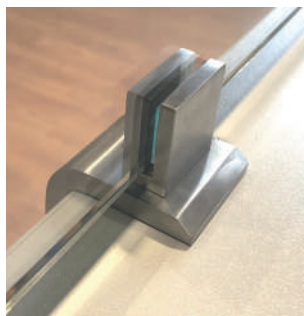

COV.3

SISTEMA FIJACIÓN DE MAMPARAS

Para vidrios/metacrilatos de 5 a 10 mm (sin agujerear) de hasta 900 mm de altura

AISI 304

Fijación a madera hasta 45 mm de grosor (sin agujerear)

Pinza giratoria para instalación en paralelo o en perpendicular

Acabados:

Inox brillo	SEP06 IB
Inox mate	SEP06 IM

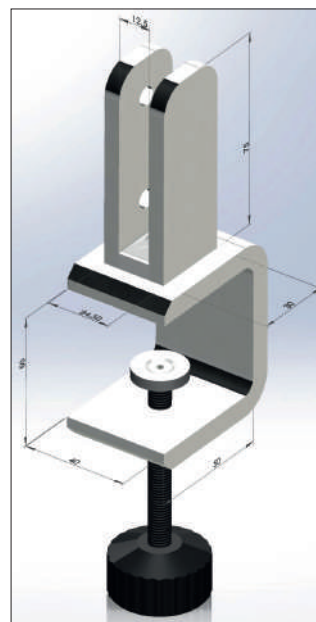

COV.6

SISTEMA FIJACIÓN PARA MAMPARA DE PROTECCIÓN

Para vidrios/metacrilatos de 5 a 10 mm (sin agujerear) de hasta 900 mm de altura

AISI 304

Acabados:

Para superficie de 30 mm

Inox brillo	SEP02.30 IB
Inox mate	SEP02.30 IM

Para superficie de 40 mm

Inox brillo	SEP02.40 IB
Inox mate	SEP02.40 IM

*Otros espesores consultar

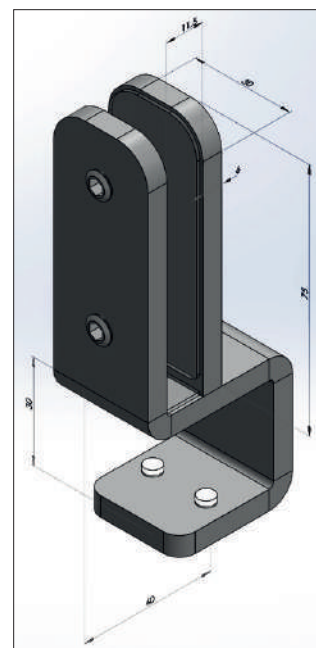
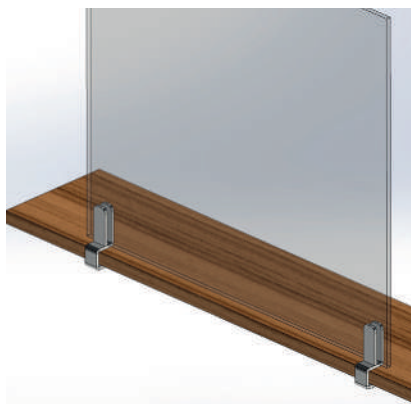

COV.4

SOPORTE DE SOBREMESA INOX PARA MAMPARAS DE PROTECCIÓN

COV.9

Para vidrios/metacrilatos de 5 a 10 mm
 Con fieltro de protección
 AISI 304
 Altura máxima: 900 mm
 Medidas pletina: 30x6 mm

Acabados:

120x120 mm

Inox brillo	SEP03.1 IB
Inox mate	SEP03.1 IM

120x50 mm

Inox brillo	SEP03.2 IB
Inox mate	SEP03.2 IM

120x50 mm + tope delantero

Inox brillo	SEP03.3 IB
Inox mate	SEP03.3 IM

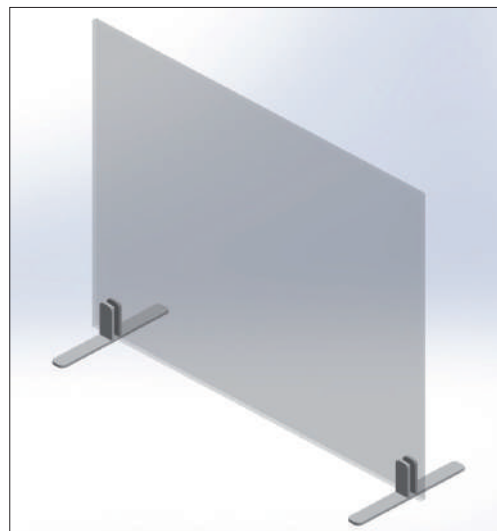
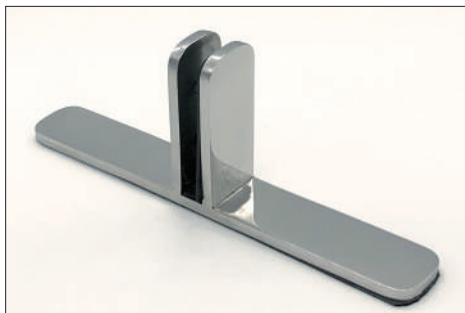

120x120 mm

120x50 mm

120x50 mm + tope delantero

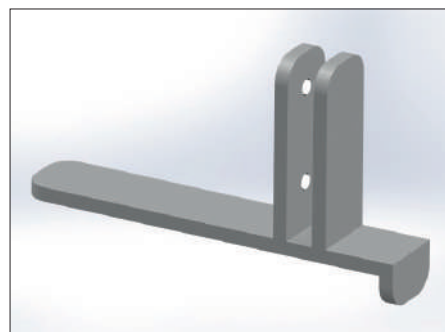
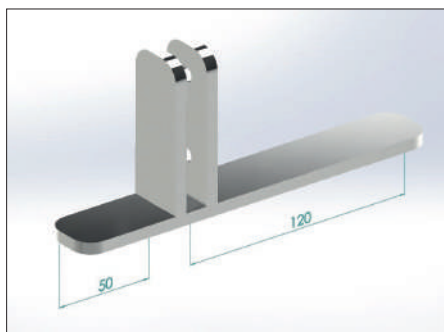
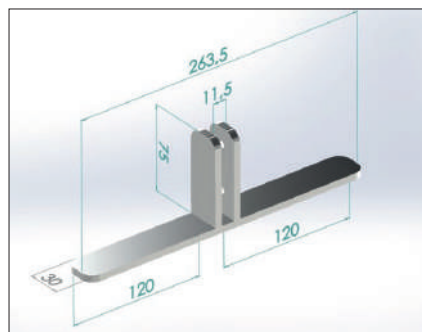

Ref. SEP03.1 IB
 Ref. SEP03.1 IM

Ref. SEP03.2 IB
 Ref. SEP03.2 IM

Ref. SEP03.3 IB
 Ref. SEP03.3 IM

MONTANTE PARA MAMPARAS DIVISORIAS

COV.5

Estables sin fijación a suelo
 Vidrios 6 a 10 mm
 AISI 304
 Base: 300 x 300 mm
 Con apoyos regulables ocultos para compensar irregularidades
 Montante: tubo 30x30 mm, altura 1200 mm
 Peso: 10 kg/unidad
 Ancho máximo entre montantes 1200 mm
 Altura máxima de suelo a vidrio 1800 mm
 Opcional con ruedas

CON DOS PINZAS

Pinza inferior a 100 mm de suelo ó a 700 mm
 Incluye 2 pinzas. La inferior con tope.

Acabados:

Inox brillo	SEP052 IB
Inox mate	SEP052 IM

CON CUATRO PINZAS

Incluye 4 pinzas. Las inferiores con tope.

Acabados:

Inox brillo	SEP054 IB
Inox mate	SEP054 IM



HERRAJES SERIE T

TORNILLO SOPORTE
RÓTULOS

Vidrio: 2/20 mm

Acabados:

Plata brillo **895 PB**

SR

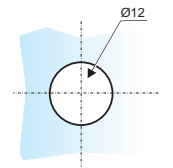
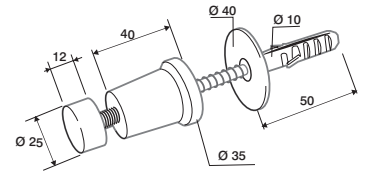

SOPORTE RÓTULOS

JUEGO 4 TORNILLOS SOPORTE
RÓTULOS

Taladro Ø 10 mm

Vidrio: 2/11 mm

Acabados:

Plata brillo **896 PB**

